

CLDE series recessed LED downlight

CLDE Series SMD LED Downlight



3 inch
CLDE-0105



4 inch
CLDE-0109



6 inch
CLDE-0118



8 inch
CLDE-0124



Back view heat sink



LED driver inside view



Spring clip system



PF > 0.9 isolated LED driver
High reliability connector



Cable clamp
Strain relief bushing
FRP isolating sleeve



Front view white coating frame

www.coolightled.com

SHENZHEN COOLIGHT OPT-ELE CO.,LTD

4/F, Bldg. C, Chuangfu Science & Technology Park, Beihuan Rd., Shiyan Town, Shenzhen, China, 518108
Tel: +86-755-8452 8176 Fax: +86-755-8452 8173 E-mail: sales@coolightled.com Website: www.coolightled.com

Product high light:

1. Coolight self-design high stability isolated constant current LED driver,
2. Excellent performance heat sink design,
3. Optimized LED arrangement and fixture design to get perfect light distribution curve,
4. Cable clamp, strain relief bushing and FRP isolating sleeve to avoid damage,
5. Well-designed cut size, ideal replacement for traditional downlights directly.

Specification:

Product Name: CLDE series recessed LED downlight

Power consumption: 7W for 3inch, 12W for 4inch, 20W for 6inch, 30W for 8inch

Heat sink material: Die-casting aluminum

LED driver type: Isolated constant current LED driver

LED driver input voltage: 100-240V AC

LED driver PF: PF>0.9

Standard CRI: CRI>80 (3000K,4000K); CRI>70 (6000K)

Beam angle: 100 degree

Color temperature: 3000k, 4000k, 6000k optional

Luminous flux: detail lumen information as following table

Product Name	Part No.	Input Voltage	Input Current (A)	Power (W)	Power Factor	Luminous flux (lm)	CCT (K)	CRI	Beame Angle	Cut Size (mm)	Weight(g)	
											N.W	G.W
3" LED Downlight	CLDE-0105	100—240VAC	0.033 (@220VAC)	7	>0.9	880	6000	>70	100°	90*90	265	325
						300	4000	>80				
						280	3000	>80				
4" LED Downlight	CLDE-0109	100—240VAC	0.057 (@220VAC)	12	>0.9	1050	6000	>70		125*125	410	490
						690	4000	>80				
						680	3000	>80				
6" LED Downlight	CLDE-0118	100—240VAC	0.096 (@220VAC)	20	>0.9	1850	6000	>70		160*160	555	660
						1300	4000	>80				
						1190	3000	>80				
8" LED Downlight	CLDE-0124	100—240VAC	0.144 (@220VAC)	30	>0.9	2400	6000	>70		190*190	790	920
						1750	4000	>80				
						1700	3000	>80				

Package information:

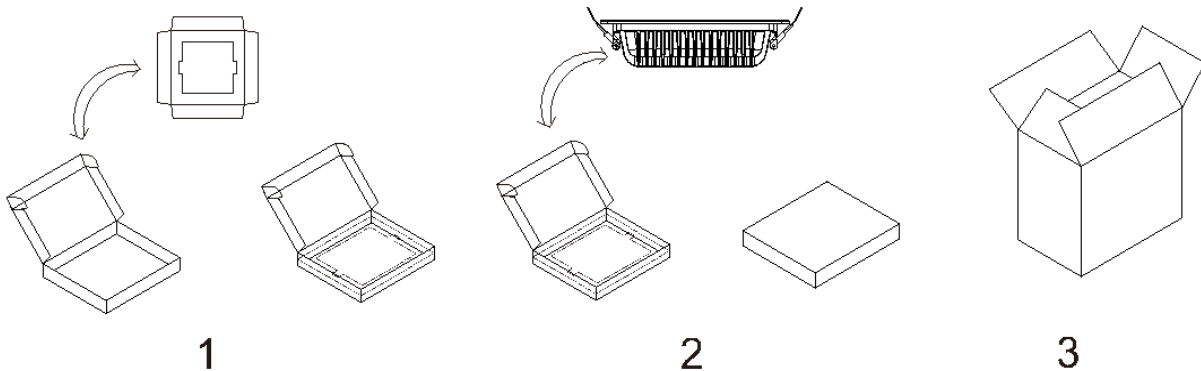

Part No.	Single box (mm)	G.W. per pcs (±5%)	Outer carton (mm)	QTY per Carton (pcs)	G.W per carton (±5%)
CLDE- 0105	120*120*95	325g	610*245*485	40	14.5kg
CLDE- 0109	190*185*70	490g	560*385*360	30	16.2kg
CLDE- 0118	250*245*75	660g	505*500*385	20	14.7kg
CLDE- 0124	250*245*75	920g	505*500*385	20	19.9kg

Cut size and installation diagram:

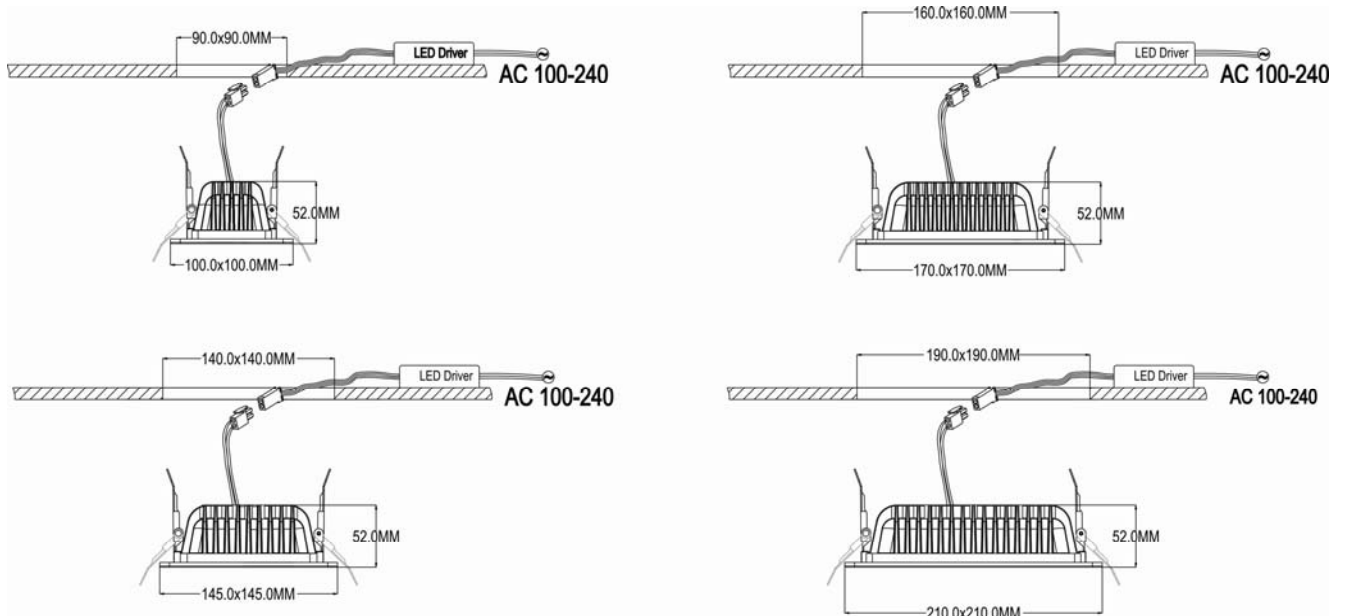

CAUTION:

- 1) Indoor use only.
- 2) Working temperature: -20-40 degree.
- 3) Please turn off power prior to installation, replacement and cleaning.
- 4) Do not try to disassemble the lamp.
- 5) Non-dimmable, can't be installed in dimming circuit.

Light Distribution Curve(cd)

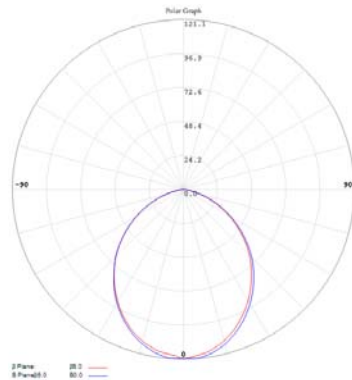

CLDE-0105

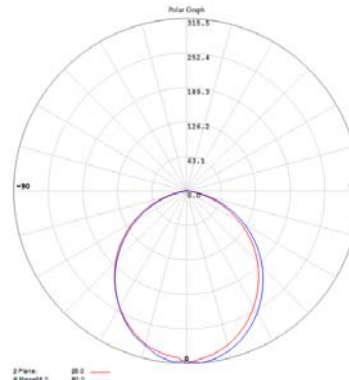

CLDE-0109

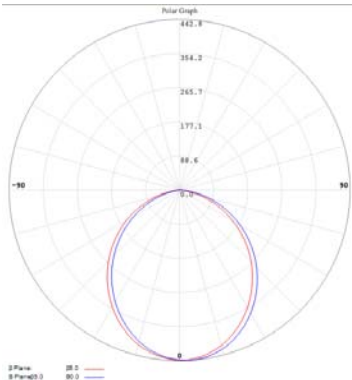

CLDE-0118

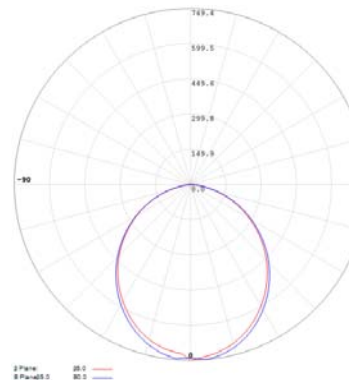

CLDE-0124

Lux test diagram

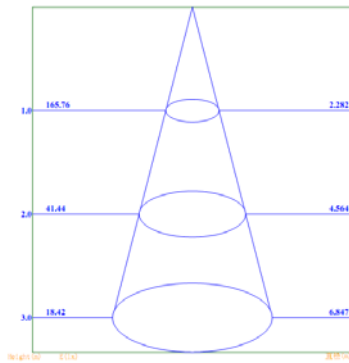

CLDE-0105

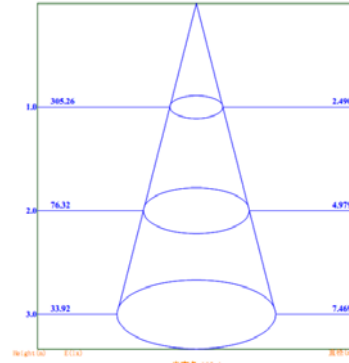

CLDE-0109

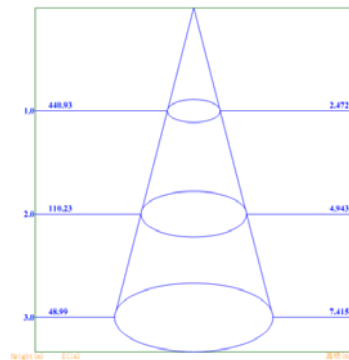

CLDE-0118

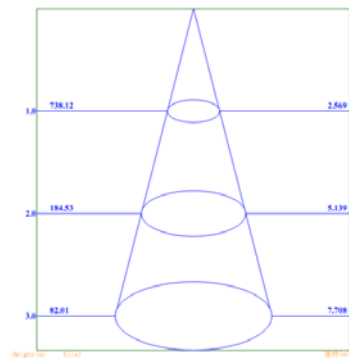

CLDE-0124